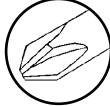

Assembly Instructions for Model 143 Add On

IMPORTANT INFORMATION!

1. If you discover any parts are missing, immediately call our toll-free service helpline at 1-800-428-8560.
2. Please save sales receipt as proof of purchase for warranty purposes.
3. You will need a phillips head screwdriver for assembly. 

Parts Identification

Note: Illustrations not shown to scale

A Door Panel (1) - Large rectangular panel with (2) doors and latch knobs. When assembled, the name plate should be in the upper left corner.

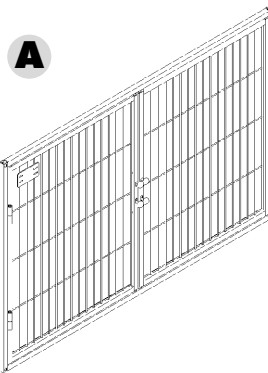

B Back Panel (1) - Large rectangular panel without doors.

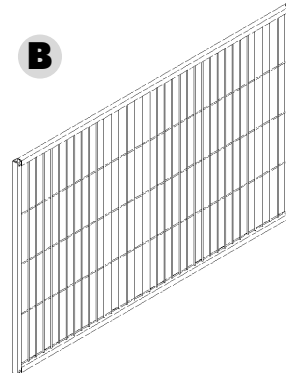

C Side Panel (2) - Smaller rectangular panel. When oriented correctly, the middle hole on the side is slightly above the middle horizontal wire. (Details in Assembly Instructions)

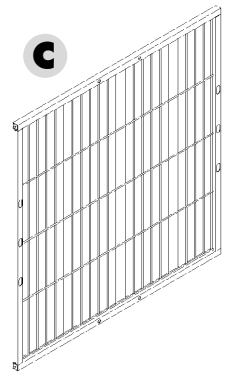

D Middle Panel Grid - Large rectangular mesh panel finished in black e-coat. There is a cut-out opening in corner.

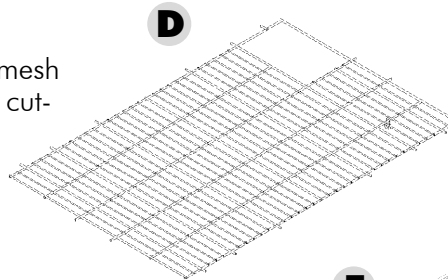

E Middle Pan - Plastic tray with a cut-out that fits in the middle of the cage.

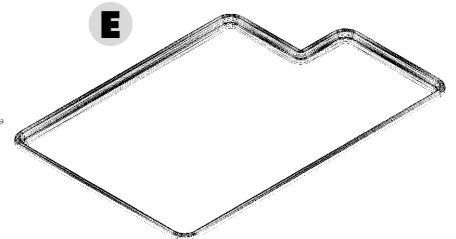

F Shelf (1) - Wire structure with plastic sheet insert.

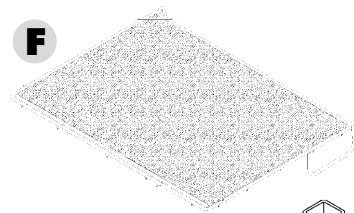

G Ladder (2) - Wire ramp for access from one level to the other. (Note: There is a slight bend in the middle. This is intentional.)

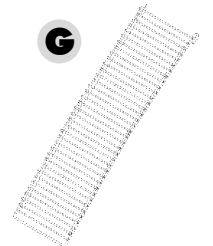

H Connector (4) - Joins the cage and stand together.

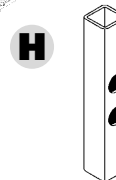

I Bolts (8) - Phillips head bolts to connect parts together.



J Washers (8) - Used with the bolts. 

K Plastic Caps (4) - Place in the openings in the top of the cage after assembly.



Assembly Instructions

Note: Although it can be assembled by one person, due to the size, you may find it easier to assemble with 2 able people.

The Instruction Manual that came with the Model 141 or 142 might be good for reference while assembling the Add On. These Instruction Manuals can be downloaded at www.midwesthomes4pets.com,

The Top Panel from the assembled cage will be removed and used as the top to the add on unit. The included Middle Grid Panel (D) will be put in place of the existing Top Panel.

If you are adding onto a fully assembled Model 141 or Model 142, you will need to disassemble a small part of the cage. If you are adding this unit while you are assembling a Model 141 or Model 142, skip to Step 9.

- 1** Remove the plastic Caps in the top of the cage that were inserted in the original 141 or 142.
- 2** Unscrew the top bolts in all 4 locations. Save the bolts and washers.
- 3** Slightly loosen the bottom screws. (These are the screws at the bottom on the same panel as the bolts that were removed.)
- 4** Slightly swing the Side Panels out enough to allow the protruding ends of the Top Grid to be exposed.
- 5** Gently pull the Door Panel and Back Panel outward to remove the Top Grid. Set the Top Grid aside for use later.
- 6** Insert the protruding ends of the included Middle Panel Grid (D) in the corresponding holes of the Door Panel and Back Panel. Make sure the wires running front to back are on top, which means the opening will either be in the back-right of the cage, or in the front-left of the cage.
- 7** Swing the Side Panels back into place, making sure the protruding ends of the Middle Grid Panel fit into the corresponding holes.
- 8** Locate 4 Connectors (H). Fit a connector in a corner post so the bottom hole of the connector meets with the top hole of the Door Panel or Back Panel. Feed a bolt with a washer through the corresponding holes. Repeat on all 4 corners. Do not fully tighten bolts at this time.

Skip to Step 10

- 9** At this point, a Middle Grid Panel should be installed with all protruding ends in the corresponding holes of the different panels, and a Connector (H) should be fit in all four corners and secured with a washer and bolt. Proceed to Step 10.

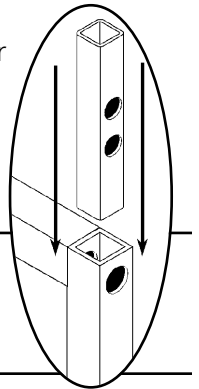

- 10** Place the Door Panel (A) onto the Connectors on the front of the cage (right above the other Door Panel.) Place the remaining Back Panel onto the connectors on the back of the cage.
- 11** Locate the Top Grid Panel and insert it between the Door and Back Panels. Make sure the wires running front to back are on top.
- 12** Locate the 2 Side Panels (C). Place them between the Door and Back Panels, making sure the protruding wires from the Bottom Panel Grid and Middle Panel Grid fit into the corresponding holes in the Side Panels. **Be sure the Side Panel is oriented correctly** by using the middle hole as a guide. When oriented correctly, the middle hole is slightly above the middle horizontal wire.

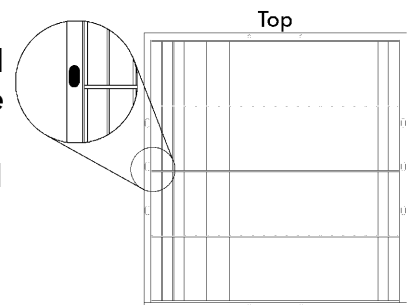

13 Locate the 4 Bolts and 4 Washers, and secure the panels together.

14 Tighten all bolts in all locations.

15 Install the 4 Plastic Caps (K) in the openings on the top of the cage.

16 Fully open the doors by pinching the knobs on the doors together.

17 Insert the Middle Pan (D) in the upper unit. Be sure the cut-out is positioned to match up with the opening in the Middle Panel Grid.

Note: The Shelves, in conjunction with the Side Panels, can be positioned at 3 different levels on either side of the cage. Although all three levels provide a ferret appropriate angle for the ramp, for these instructions, the middle position will be demonstrated.

18 Locate one Shelf (I) and with the doors open in the top unit, tilt the Shelf down and insert the end of the hook in the middle holes on the right side of the top unit. Lift the Shelf up and let hook fall into place.

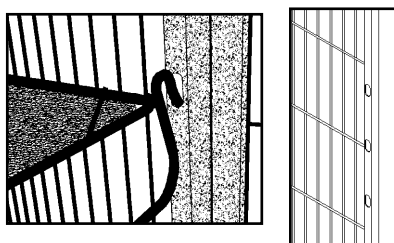

19 Before inserting the Shelf in the bottom unit, install the Ramp (J) that will allow your ferret go from one level to the next. Attach the hooks on the end of the ramp to the back wire in the opening of the Middle Panel Grid.



20 This ramp has the ability to be secured in the "up" position to section off the top level from the bottom level. Before inserting the Shelf in the bottom unit, swing this ramp up and hook it with the attached "S" hook. (For illustration purposes, this is shown without the pan installed.)

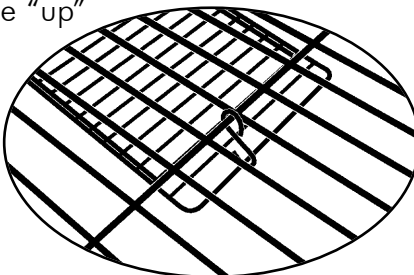

21 Install Shelf in bottom unit as in Step 19.

22 Attach the remaining ladders on the shelves. Slightly tilt the shelf up and slip the hooks of the ladder onto the outermost wire on the shelf. To keep the shelf from moving from side to side, be sure the ladder hooks are placed in the openings as shown.

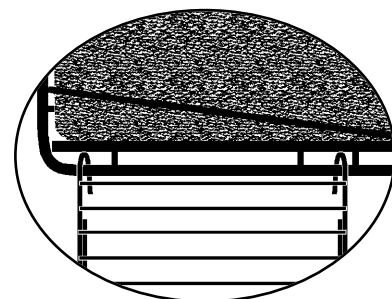
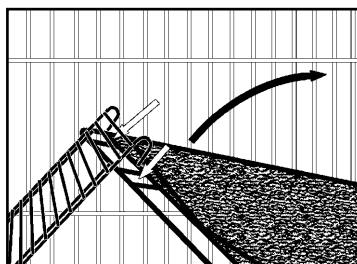

Ferret Nation
THE
• World's Best Ferret Habitat •

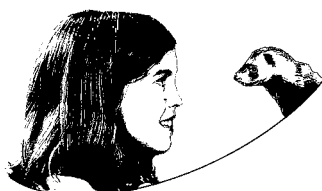

MIDWEST
HOMES FOR PETS